

Transferring DVCAM/MiniDV

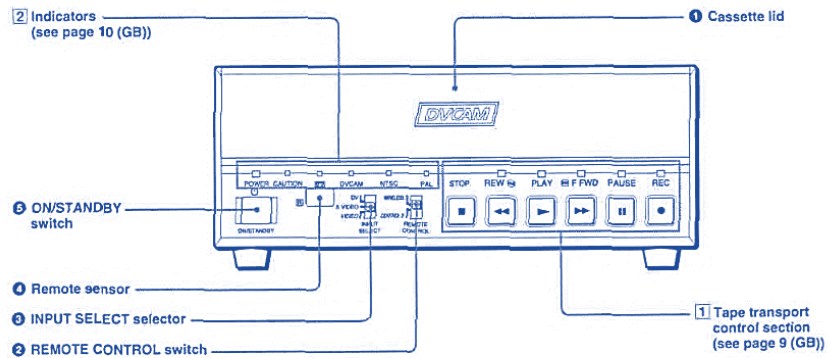

Step 1: Setup

What to do with the Switcher

- Make sure the Switcher is set to **Input 3: DVCAM**



What to do with the DVCAM deck

- Make sure the DVCAM deck is powered on. The light should be green.
- Gently insert your tape into the DVCAM deck. The cassette will automatically load once placed in the proper position.

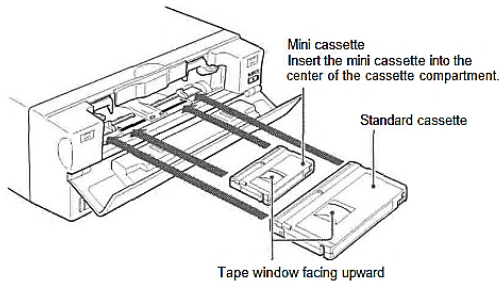

Step 2: Open Elgato Video Capture

- Close all open programs, if any, on the Mac.
- Click on the **Elgato Video Capture** icon in the dock at the bottom of the screen.



Step 3: Getting started

- **Elgato Video Capture** will open to this window:

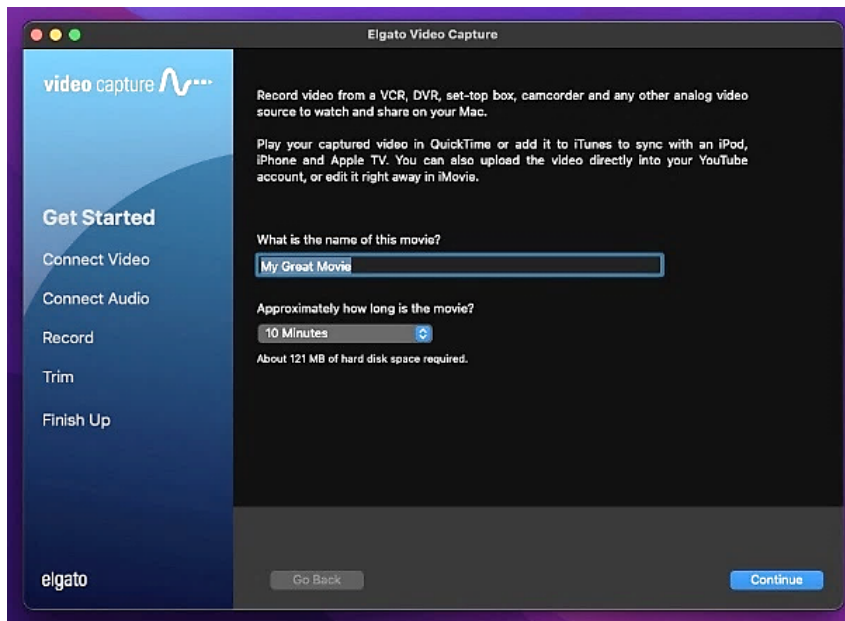

- Give your movie a title.
- Click on CONTINUE.

Step 4: Connect video

- Press the **PLAY** button on the DVCAM deck to preview your movie.

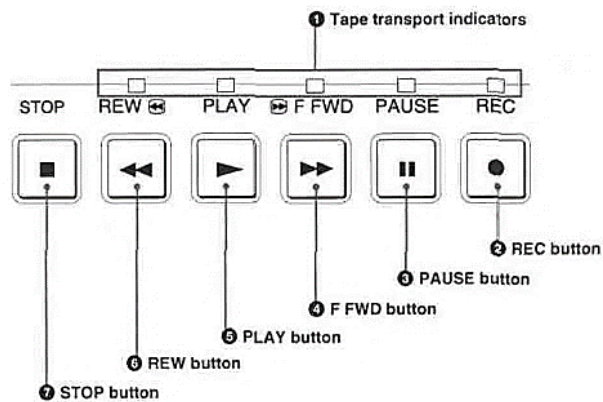

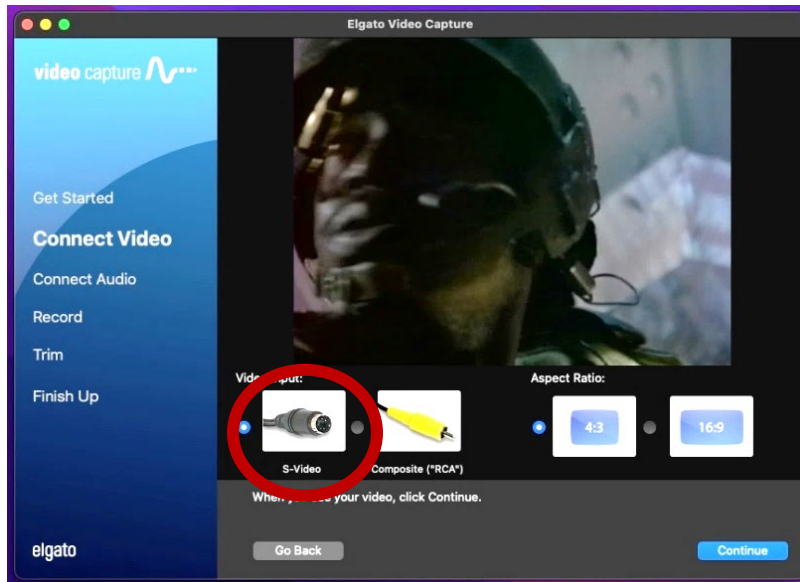

- Make sure S-VIDEO is selected in the software under **Video Input**.
- Use the **Aspect Ratio** option to select the most appropriate ratio for your movie. For most home movies, use 4:3.
- Click CONTINUE.
- If you can hear audio, but cannot see your video in the **Elgato** software, make sure all other programs are closed and restart **Elgato**. If problems persist, contact an SFPL staff member.

Step 5: Connect Audio

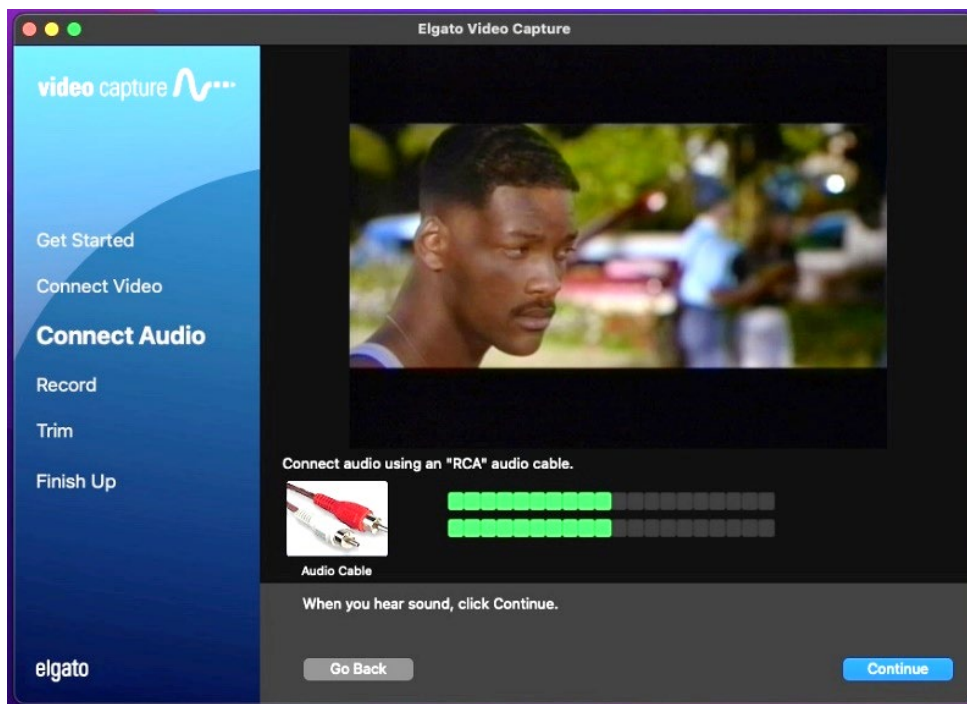

- With your movie playing, you should see moving green bars that represent your movie's audio track. Make sure you are viewing a portion of your video that contains audio.
- If both audio and video signals appear correct, press STOP on the DVCAM deck, then press REWIND to go back to the beginning of the tape.
- Select CONTINUE on the **Elgato Video Capture** software.

Step 6: Record

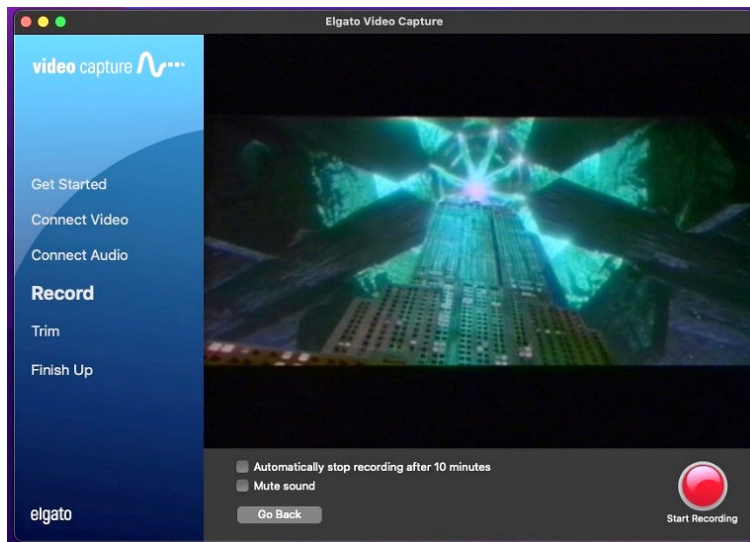

- Select START RECORDING on the **Elgato Video Capture** software.
- Press PLAY on the DVCAM deck.
- You should again see your movie playing in the **Elgato** window.
- When you want to stop recording, press the STOP RECORDING button in the software, then press STOP on the DVCAM deck.

Step 7: Trim (OPTIONAL)

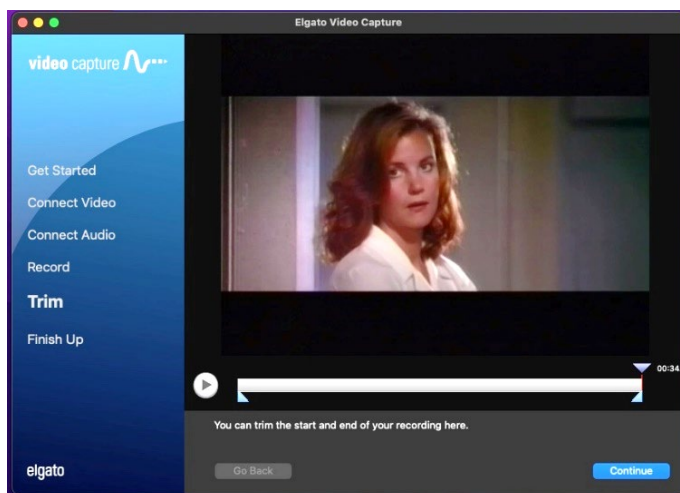

- **If you are unsure of your video editing skills, this step can be skipped, as it cannot be undone once you click CONTINUE. We highly recommend skipping this step.**
- Move the tabs underneath the video screen to trim the ends of your digitized movie.
- Click CONTINUE.

Step 8: Finish up

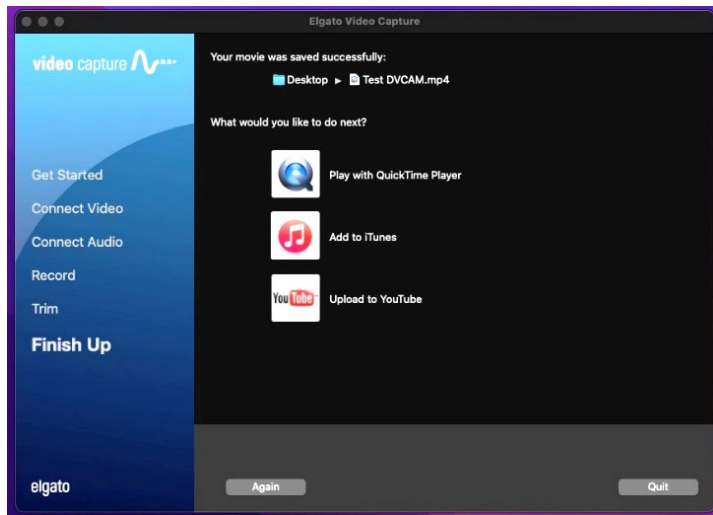

- **IMPORTANT: DO NOT** click AGAIN or QUIT before the file is created, or you might lose all your work!
 - Before starting on another tape, make sure to let the program finish creating the video file for what you just digitized. Please also test the newly created file by following the step below.
- Once the file has finished rendering, select Play with QuickTime Player. If you choose this option and get an error message, your movie is still rendering. Wait a few seconds and try selecting Play with QuickTime Player again.
- After you have tested your file, if you want to digitize another movie, click AGAIN and go back to **Step 1**.
- If you are finished, click QUIT.

Step 9: Save your video on your storage device

- Plug in your storage device to the USB hub.
- Drag your movie from the desktop to the disk image of your storage device.
- Safely eject your device from the computer by dragging its disk image to the eject icon (trash can) on the bottom of the desktop. Or you can click on the drive and select **File → Eject**.



- Eject your tape from the DVCAM deck using the button located at the right side of the cassette compartment

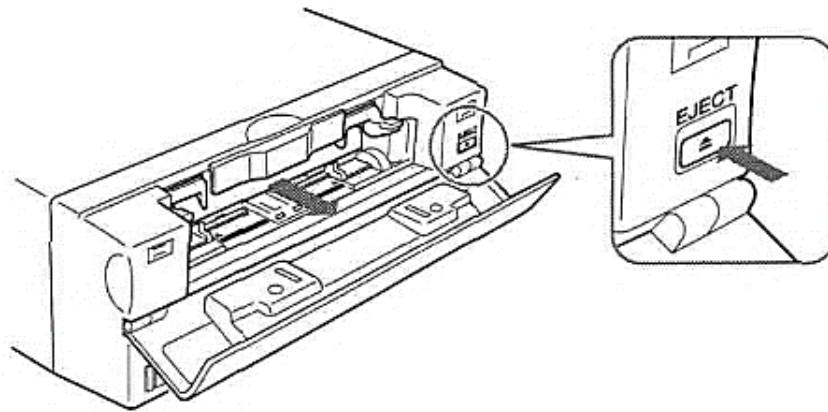

Don't forget your tape and storage device!

